

BUYING GUIDE

Professional office

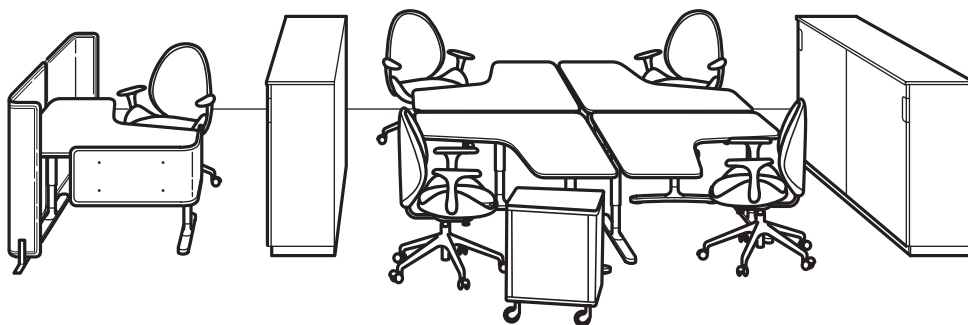

Furniture for every office

We have furniture for every kind of office – from the small to the fully staffed. And everything to make a modern company run smoothly and efficiently, from desks, storage and chairs, down to lamps and desk accessories. Choose between desks of different sizes and shapes, comfortable work chairs that support your back – and finish by creating a unique storage solution for your needs. At IKEA our office furniture has great design, smart functions and high quality. And it's been tested for office use so you can be sure it can take tough days at work – year after year.

All the products (shown here) may not be available at the store. Please contact the staff or look at www.IKEA.co.id for more information. For more detailed product information, see the pricetag and the Internet. All units require assembly.



CONTENT

Desks and conference tables	4
Storage.....	12
Workchairs	22
Service offer.....	28

Do it yourself or let us help

Just because you can do everything yourself, doesn't mean you have to. Let us help make your office solution a reality with our service offers like picking, home delivery, assembly, financing and more. Read more on the back page of this guide or at www.IKEA.co.id.

GOOD TO KNOW

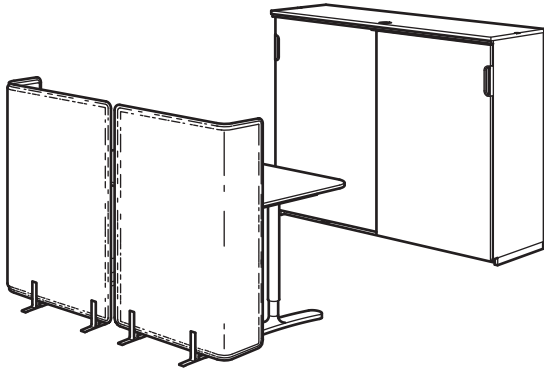

Versatile screens for many needs.

Our screens serve different needs. You can use them to create a pleasant and welcoming reception area, to provide privacy in an open plan office or to reduce sound. Or all these things. The screens come in two heights, 120 cm and 55 cm. The 120 cm screen stands freely on the floor. The 55 cm screen attaches easily to BEKANT table top and can be mounted at two different heights, according to your needs.

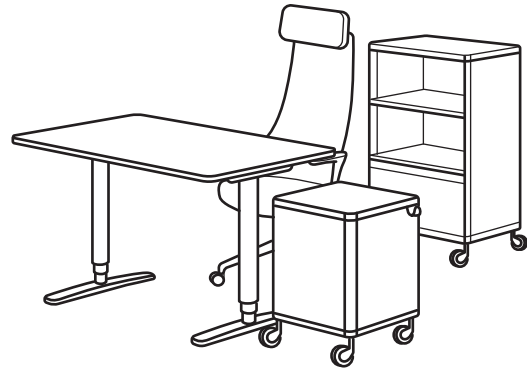

Flexible storage on less space.

BEKANT storages on wheels are easy to get out of the way when you want to turn the workplace into something else. Small office supplies fit perfectly in small storage and high unit can also be used as presentation desks.

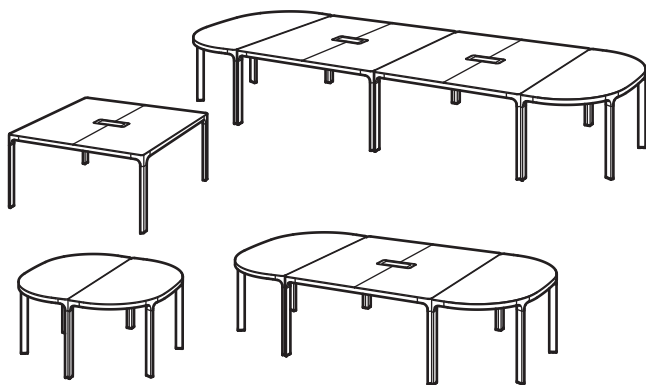

Combine to create your own conference table.

We have conference tables in two sizes – 140×140 cm and 140×70 half round. The half round table seats 3 and the 140×140 cm table seats 8. You can use them individually or combine them to seat as many people as you need. And simply rearrange tables when your needs change. Attachment clips to connect the tables are included with the frames.



More desks on less space.

By placing desks back to back you can save space. You can do this with desks of different shapes and sizes. For instance, straight desks back to back or four corner desks with their corners meeting at the centre. There are many possibilities. This back-to-back desk arrangement saves time and makes it easier for colleagues that work in teams to communicate and collaborate. You can also choose to put screens between the desks to create more individual and private workspaces.

DESKS AND CONFERENCE TABLES

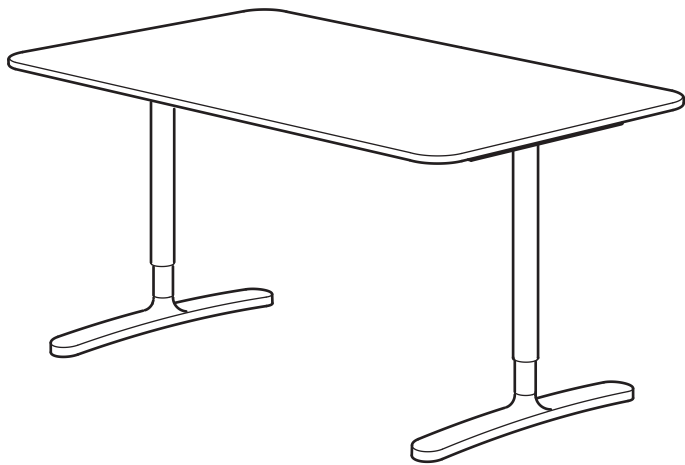

Desks for many different needs

BEKANT desks come in many shapes and sizes, so it's easy to find one that perfectly suits your needs. A net for cable management is included and helps you keep the area around your desk free of messy cables. If you want to have a softer surface, you can choose Linoleum table top which has natural ingredients in it. It's so nice to write on it. It's also kind to your eyes as it doesn't reflect the light.

Tested for tough treatment

The BEKANT, IDÅSEN and THYGE desk series have been tested according to the highest standards for professional office use (EN 527, ANSI/BIFMA X:5.5 for desks and EN14074, EN1730 and ANSI/BIFMA X:5.5 for conference tables) and meets our strict standards for quality and durability.

That means that the series has undergone a number of tough tests. And this is how we know that all the desks are durable and can take heavy loads and that the surfaces resist both scratches and strains. This makes them a reliable workmate that lives up to your high demands and can withstand hard work – day after day, year after year.

Free your creativity

BEKANT conference tables have a built-in solution for cable management. This means that you and your colleagues can use computers and projectors without lots of loose cables tangling around your coffee cups and papers. Focus on the right things releases creativity.

Design

BEKANT: Karl Malmvall, Eva Lilja Löwenhielm
IDÅSEN: Jon Karlsson

Care instructions

Wipe clean with a mild soapy solution.



Read more in the guarantee brochure.



"Desk Control" app can only be used for IDÅSEN sit/stand desks in some languages*. Go to your Google Play or APP store to download the Desk Control app. The app will take you through the process of installing your Desk Control.

*English, German, French, Italian, Spanish, Japanese, Chinese, Korean

GOOD TO KNOW

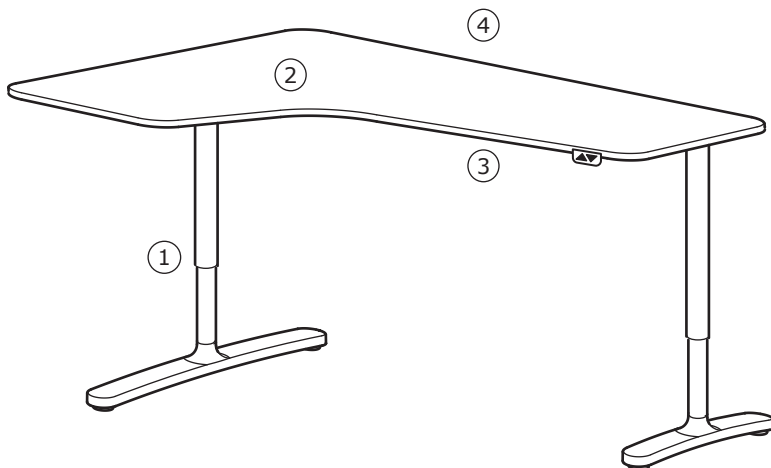

1. Height adjustable legs allow you to assemble your desk at a height that suits you. If you have the sit/stand underframe you can raise and lower the desk with the touch of a button.
2. The curved shape of the table top gives support to your wrists and forearms when typing.

3. It's easy to keep your desk neat and tidy with the cable management net under the table top.
4. Surfaces in veneer and melamine foil are hardwearing, stain resistant and easy to keep clean.

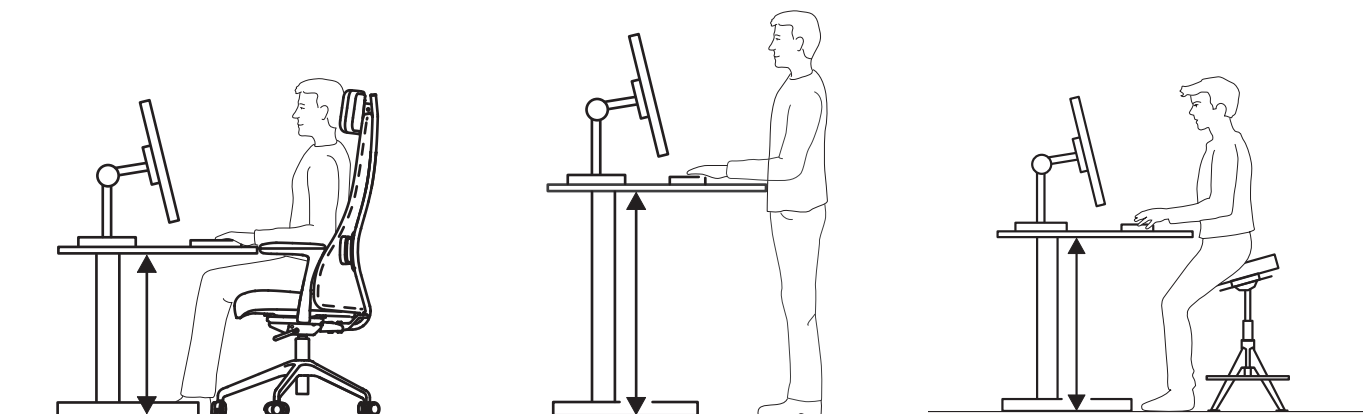

With BEKANT and IDÅSEN sit/stand underframe you can raise and lower your desk by the simple touch of a button. That helps you to change working positions often and keeps your body active. The positions for sitting and standing are from 65 cm to 125 cm for BEKANT and from 60 cm to 124 cm for IDÅSEN sit/stand desks.

You can use TROLLBERGET active sit/stand support to get a more open posture which is good for your blood circulation and core muscles.

COMBINATIONS



Adjustable in height. With our BEKANT sit/stand desk you can adjust the height of the table top electrically from 65 to 125 cm to ensure an ergonomic working position. Changing positions between sitting and standing helps you move your body so you both feel and work better.

This combination (160×80 cm)

Table top in white

with a **sit/stand underframe** in black or white

Rp10.795.000

Table top in black stained ash veneer, white stained oak veneer, linoleum blue

with a **sit/stand underframe** in black or white

Rp11.095.000

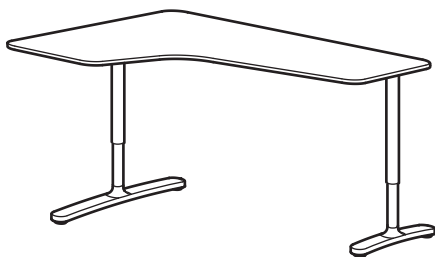

Ergonomic workspace. BEKANT contoured table top provides support to the wrists and forearms when writing, relieving strain on your shoulders during long working hours.

This combination (160×110 cm)

Table top in white

with a **sit/stand underframe** in black or white

Rp10.995.000

Table top in black stained ash veneer, white stained oak veneer, linoleum blue

with a **sit/stand underframe** in black or white

Rp11.295.000

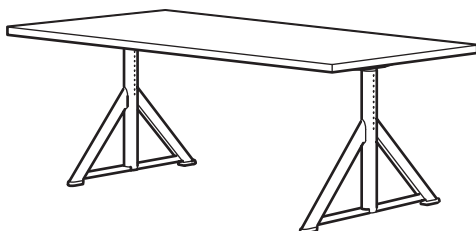

Generous workspace. IDÅSEN table top gives a generous work surface and lets you sit at a comfortable distance from the computer.

This combination (160×80 cm)

Table top in black or brown

with **underframe** in beige or dark grey

Rp3.995.000

COMBINATIONS

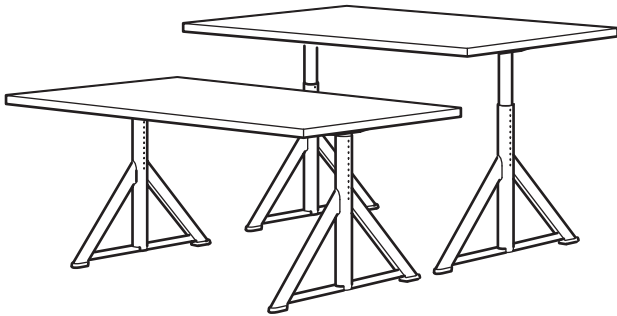

Adjustable and flexible. With IDÅSEN sit/stand desk you can adjust the height of the table top electrically from 60 to 124 cm to ensure an ergonomic working position for yourself. You can also use a “desk controller” app to set your favorite heights if you share your desk.

This combination (120×70 cm)

Table top in black or brown
with a **sit/stand underframe** in beige
or dark grey

Rp10.695.000

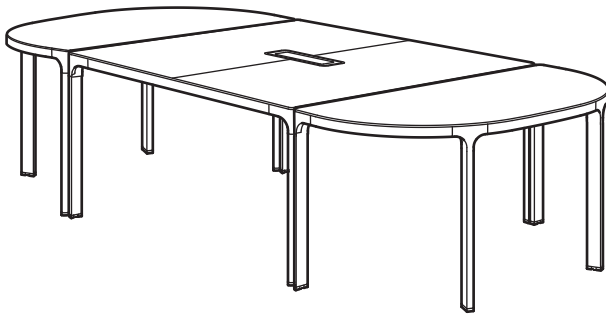

Meeting place. The BEKANT conference table has a built-in solution for cable management; keep computers and projector cables organised and close at hand at the table.

This combination (280×140 cm)

Table top in white
with an **underframe** in black or white **Rp8.585.000**



Table top in black stained ash veneer, white
stained oak veneer

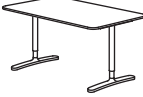

with an **underframe** in black or white **Rp9.185.000**

BASIC COMBINATIONS

BEKANT

		
Size	160×110 cm, left or right	160×80 cm
Table top in white with underframe in black or white colour	Rp3.995.000	Rp3.495.000
with sit/stand underframe in black or white colour	Rp10.995.000	Rp10.795.000
Table top in black stained ash veneer, white stained oak veneer, linoleum blue with underframe in black or white colour	Rp4.295.000	Rp3.795.000
with sit/stand underframe in black or white colour	Rp11.295.000	Rp11.095.000



			
Size	140×70 cm, half-round	140×140 cm	2× 140×70 cm, half-round
Table top in white with underframe in black or white colour	Rp2.395.000	Rp3.795.000	Rp4.790.000
Table top in black stained ash veneer, white stained oak veneer with underframe in black or white colour	Rp2.595.000	Rp3.995.000	Rp5.190.000

		
Size	1× 140×140 cm 2× 140×70 cm half round	2× 140×140 cm 2× 140×70 cm half round
Table top in white with underframe in black or white colour	Rp8.585.000	Rp12.380.000
Table top in black stained ash veneer, white stained oak veneer with underframe in black or white colour.	Rp9.185.000	Rp13.180.000

THYGE

	
Size	120×60 cm
Table top in white with frame and leg in silver-colour	Rp1.499.000

IDÅSEN

		
Size	120×70 cm	160×80 cm
Table top in brown and black with underframe in beige or dark grey colour	Rp3.495.000	Rp3.995.000
with sit/stand underframe in beige or dark grey colour	Rp10.695.000	Rp11.195.000

ALL PARTS AND PRICES

BEKANT



BEKANT table top corner right 160×110 cm. To be completed with BEKANT underframe for corner table top.

White	303.535.09	Rp1.995.000
White stained oak veneer	003.662.83	Rp2.295.000
Black stained ash veneer	503.662.85	Rp2.295.000
Linoleum blue	103.662.87	Rp2.295.000



BEKANT table top corner left 160×110 cm. To be completed with BEKANT underframe for corner table top.

White	302.534.96	Rp1.995.000
White stained oak veneer	203.662.77	Rp2.295.000
Black stained ash veneer	803.662.79	Rp2.295.000
Linoleum blue	403.662.81	Rp2.295.000



BEKANT table top 160×80 cm. To be completed with BEKANT underframe for table top 160 cm.

White	803.535.35	Rp1.795.000
White stained oak veneer	803.663.02	Rp2.095.000
Black stained ash veneer	403.663.04	Rp2.095.000
Linoleum blue	903.663.06	Rp2.095.000



BEKANT underframe for corner table top 160×110 cm. To be completed with BEKANT corner table top. You can mount the table top at a height that suits you, since the legs are adjustable between 65-85 cm.

White	502.529.72	Rp2.000.000
Black	302.529.73	Rp2.000.000



BEKANT underframe for table top 160×80 cm. To be completed with BEKANT table top 160 cm. You can mount the table top at a height that suits you, since the legs are adjustable between 65-85 cm.

White	102.529.07	Rp1.700.000
Black	702.529.09	Rp1.700.000



BEKANT underframe sit/stand for corner table top. To be completed with BEKANT corner table top, left or right. You can adjust the height electrically from 65-125 cm to ensure an ergonomic working position.

White	702.529.71	Rp9.000.000
Black	902.529.70	Rp9.000.000



BEKANT underframe sit/stand for table top 160 cm. To be completed with BEKANT table top 160×80 cm or BEKANT 5-sided table top 160×80 cm. You can adjust the height electrically from 65-125 cm to ensure an ergonomic working position.

White	002.552.56	Rp9.000.000
Black	502.552.54	Rp9.000.000

THYGE



THYGE table top 120×60 cm. To be completed with THYGE frame 120 cm.

White	603.543.00	Rp699.000
-------	------------	------------------



THYGE frame 120×60. To be completed with THYGE table top 120 cm.

Silver colour	702.937.78	Rp800.000
---------------	------------	------------------

IDÅSEN



IDÅSEN table top 120×70 cm. To be completed with IDÅSEN underframe for table top 120 cm.

Brown	303.821.92	Rp1.695.000
Black	004.038.79	Rp1.695.000



IDÅSEN table top 160×80 cm. To be completed with IDÅSEN underframe for table top 160 cm.

Brown	203.609.92	Rp2.195.000
Black	404.038.82	Rp2.195.000



IDÅSEN underframe sit/stand for table top 120 and 160 cm. To be completed with IDÅSEN table tops 120 and 160 cm. You can adjust the height electrically from 60-124 cm to ensure an ergonomic working position.

Beige	204.151.12	Rp9.000.000
Dark grey	804.151.14	Rp9.000.000



IDÅSEN underframe for table top 120 and 160 cm. To be completed with IDÅSEN table tops 120 and 160 cm. You can mount the table top at a height that suits you, since the legs are adjustable between 62-76 cm.

Beige	803.609.89	Rp1.800.000
Dark grey	903.980.91	Rp1.800.000

ALL PARTS AND PRICES

CONFERENCE TABLES

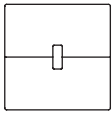

BEKANT conference table top 140x140 cm.
To be completed with BEKANT frame for table top 140x140 cm.

White	003.535.20	Rp1.995.000
Black stained ash veneer	203.667.48	Rp2.195.000
White stained oak veneer	603.667.46	Rp2.195.000



BEKANT frame for table top 140x140 cm. To be completed with BEKANT conference table top 140x140 cm.

White	302.528.74	Rp1.800.000
Black	202.528.79	Rp1.800.000



BEKANT conference table top half-round 140x70 cm. To be completed with BEKANT frame for half-round table top 140x70 cm.

White	203.535.24	Rp1.095.000
Black stained ash veneer	403.667.52	Rp1.295.000
White stained oak veneer	603.667.51	Rp1.295.000



BEKANT frame for half-round table top 140x70 cm. To be completed with BEKANT table top 140x70 cm.

White	802.528.81	Rp1.300.000
Black	002.528.80	Rp1.300.000

ALL PARTS AND PRICES

DESK ACCESSORIES

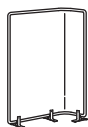

BEKANT screen 120 cm. The screen creates a quiet and pleasant working environment by providing privacy and absorbing sound.

Grey 302.688.13 **Rp1.999.000**



BEKANT screen 55 cm. The screen creates a quiet and pleasant working environment by providing privacy and absorbing sound. Can be mounted at two heights to suit different needs.

Grey 902.688.10 **Rp1.299.000**



KVISSLE letter tray. Cork liner in the bottom keeps the papers in place. Pull-out compartments make it easy for you to access your papers. You can also turn the letter tray on its side if you want to store and organise your papers vertically.

White 802.039.56 **Rp349.000**

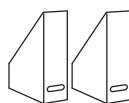

KVISSLE magazine file, set of 2. Easy to pull out and lift as the magazine file has a handle.

White 202.039.59 **Rp199.000**

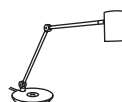

RIGGAD work lamp with wireless charging. You can easily wirelessly charge your smartphone, just place it on the built-in charger and charging begins.

White 603.856.36 **Rp1.199.000**

STORAGE

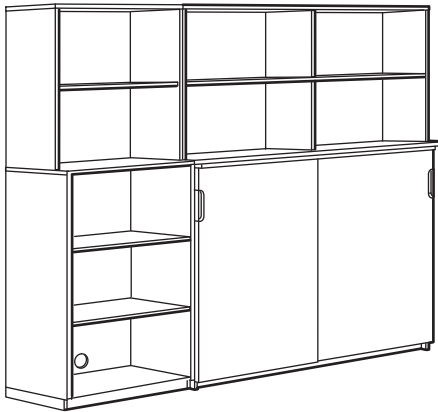

GALANT

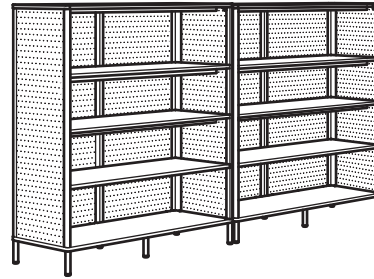

BEKANT

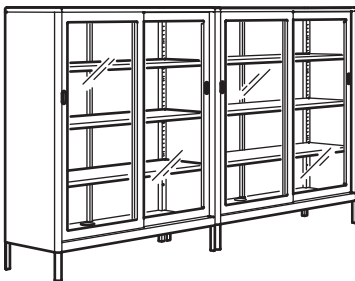

IDÅSEN

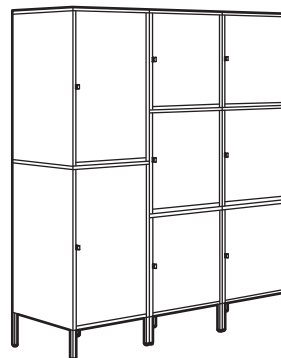

HÄLLAN

Professional and personal

You can choose between GALANT, BEKANT, IDÅSEN and HÄLLAN storage according to your needs and style. They have been specially developed to suit all types of professional offices – both when it comes to smart functions and high quality. You can choose, for example, between different height and widths, storage with only drawers or combined with file storage and drawer units. You can also use some of the pieces in the series as room dividers – a good way to create a calm corner to work in.

All storage at the office

Everything from binders and paper to printers and computers – not to mention cords and cables. Our storage series solves all of the most important and usual storage needs at the office. In GALANT, all units have built-in cable management and ventilation to ensure there's no risk of your electronic equipment overheating. HÄLLAN cabinets are designed as modules, so you can use one or buy several and create a combination that suits you. It helps you keep track of everything from your handbag, laptop charger and wallet to important papers. Most of the BEKANT and IDÅSEN storages have wheels so you can change your workspace into something else when you are done.

Tested for a long, hard life at work

All storage units have been tested for office use and meet the requirements for safety, durability and stability set forth in the following standards: EN 14073, EN14074, ANSI/BIFMA x5.9 and ISO-7170.

That means that they have undergone a number of tough tests. For example, we've made sure that the surfaces can withstand heavy wear and tear, and that all drawers and sliding doors will run smoothly even after a long time.

Design

BEKANT and GALANT storage: Karl Malmvall, Eva Lilja Löwenhielm

HÄLLAN and IDÅSEN: Jon Karlsson

Care instructions

Wipe clean with a mild soapy solution.



Read more in the guarantee brochure.

HOW TO COMBINE

BEKANT

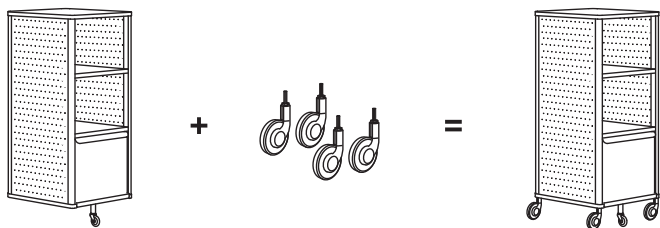

HÄLLAN

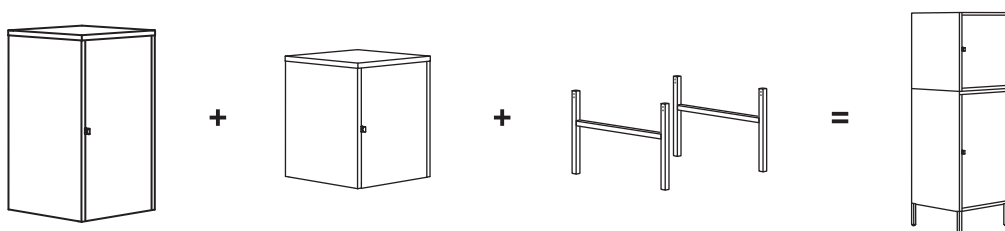

GALANT

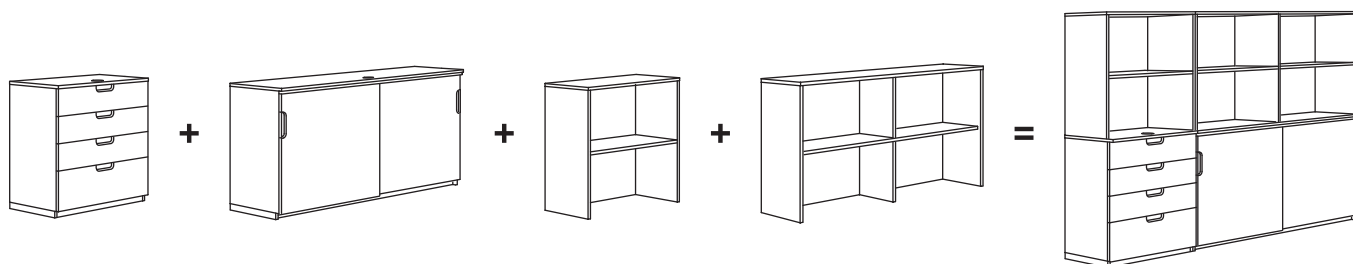

GALANT LOCK – GOOD TO KNOW

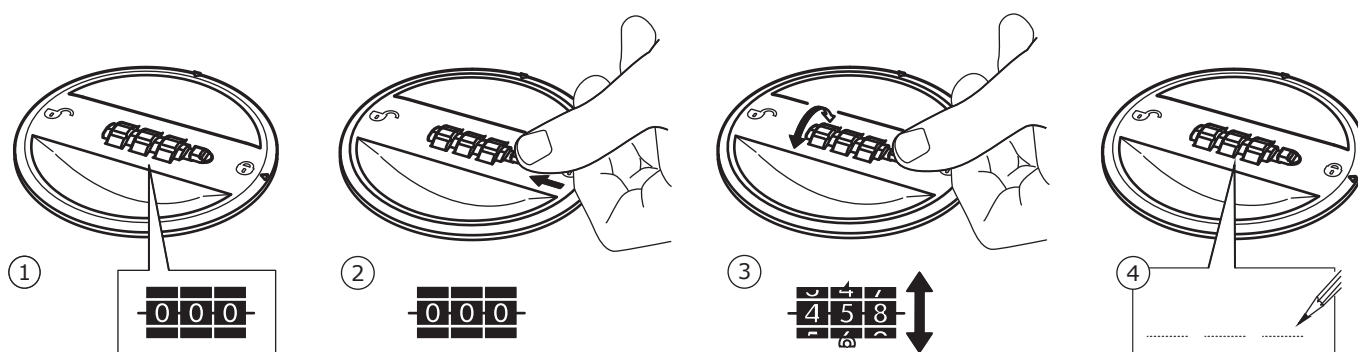

GALANT COMBINATIONS

Overall size: Width×Depth×Height.

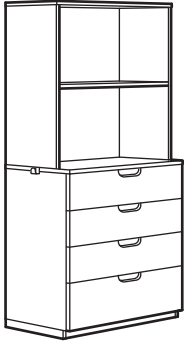

A simple unit can be enough storage for a limited space or the foundation for a larger storage solution if your needs change. Use an add-on unit to build vertically; makes optimal use of wall space and saves space on the floor.
Overall size: 80×45×160 cm.

This combination
in white stained oak veneer Rp7.999.000(392.851.63)

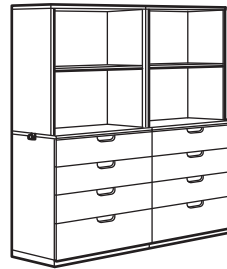

Maximum storage. 2 drawer units each with 4 drawers and 2 add-on units; make it easy to store important papers and have an open storage at the same time.
Overall size: 160×45×160 cm.

This combination
in white Rp14.398.000 (492.850.68)

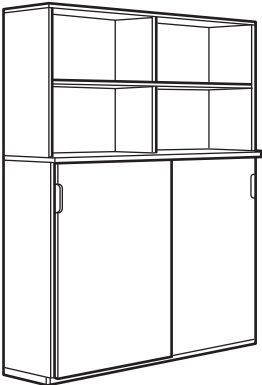

Combine open and closed storage; hide or display your things according to your needs.
Overall size: 160×45×200 cm.

This combination
in white stained oak veneer Rp11.799.000

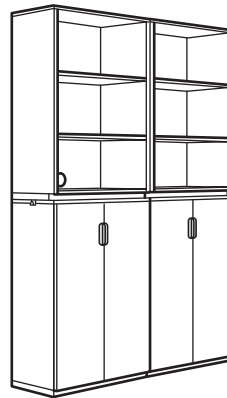

A complete storage solution with both open and closed storage.
Overall size storage: 320×45×120 cm.

This combination
in white Rp13.596.000 (092.857.82)

BEKANT COMBINATIONS

Overall size: Width×Depth×Height.

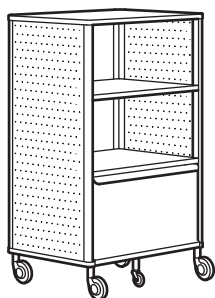

Roll it to wherever you need it. You can also use it as a reception desk thanks to the generous work surface. Overall size: 61×45×101 cm.

This combination
in mesh white Rp3.799.000 (892.825.48)

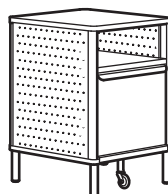

Perfect size to use it under your desk. It's suitable to sit on and easily transforms into an extra chair for your guests. Overall size: 41×45×61 cm.

This combination
in mesh black Rp2.199.000 (292.824.24)

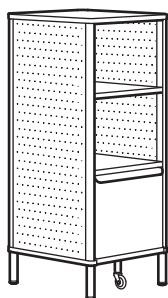

Combine the storage with legs and smart lock. It can also be used as presentation desk since it has a cable management hole. Overall size: 41×45×101 cm.

This combination
in mesh white Rp3.199.000 (892.825.29)

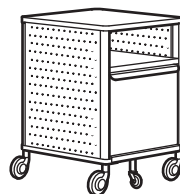

Roll it to wherever you need it. It's also approved for short time seating so you can use as an extra seat for your visitors too. Overall size: 41×45×61 cm.

This combination
in mesh black Rp2.299.000 (992.824.30)

IDÅSEN

Overall size: Width×Depth×Height.



Roll it to wherever you need it.
Overall size: 42×47×61 cm.

in dark grey Rp1.799.000 (103.609.83)

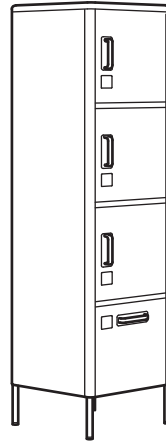

High unit with many drawers means plenty of storage on a minimum of floor space. Overall size: 42×47×172 cm.

in beige Rp2.999.000 (103.207.32)



You can use the storage with doors to keep your common documents or objects.
Overall size: 80×47×119 cm.

in blue Rp3.999.000 (203.979.43)

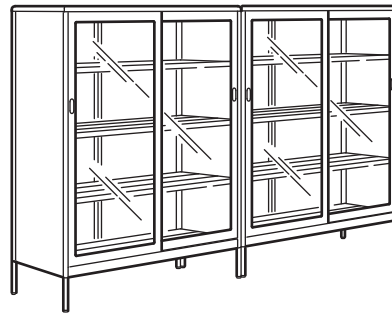

You can get an overview of what's in the cabinets and can protect your stuff from dust with the glass doors. They also give an opportunity to show visitors things you are extra proud of. It's office approved but it may fit perfectly to your home as well.
Overall size: 240×45×280 cm.

in beige Rp9.998.000 (2×603.609.52)

HÄLLAN COMBINATIONS

Overall size: Width×Depth×Height.

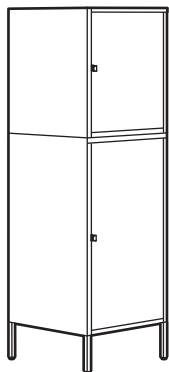

HÄLLAN storage combination with doors. Perfect combination for small spaces at your home or at your office. You can add new cabinets whenever you want. They can be locked with standard padlocks.
Overall size: 45×47×142 cm

This combination in white Rp**1.340.000** (392.494.10)

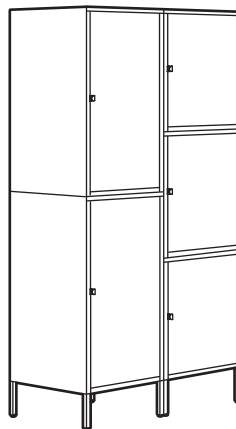

HÄLLAN storage combination with doors. Suitable for your office or your home to keep everything in order. You can add new cabinets whenever you want. They can be locked with standard padlocks.
Overall size: 90×47×167 cm

This combination in white Rp**3.225.000** (792.495.21)

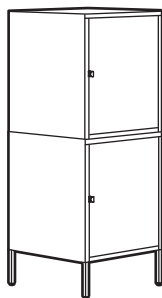

HÄLLAN storage combination with doors. Perfect combination for small spaces at your home or at your office. You can add new cabinets whenever you want. They can be locked with standard padlocks.
Overall size: 45×47×117 cm

This combination in white Rp**1.190.000** (592.493.29)

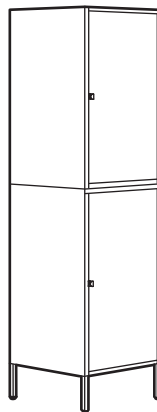

HÄLLAN storage combination with doors. Perfect combination for small spaces at home or at your office. You can add new cabinets whenever you want. They can be locked with standard padlocks.
Overall size: 45×47×167 cm

This combination in white Rp**1.490.000** (692.494.04)

HÄLLAN COMBINATIONS

Overall size: Width×Depth×Height.

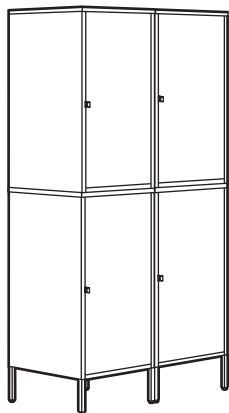

HÄLLAN storage combination with doors. You can use this combination at your office or at your home to keep your personal belongings or your folders and important papers. You can add new cabinets whenever you want. They can be locked with standard padlocks.
Overall size: 90×47×167 cm

This combination in white Rp**2.980.000** (992.494.07)

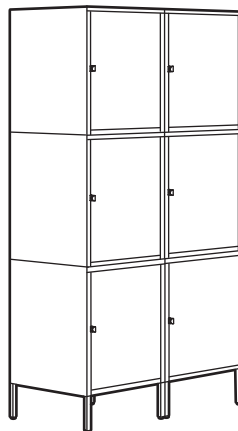

HÄLLAN storage combination with doors. Everything is in one place. Lock your bags, wallets, keys and papers with standard padlocks and keep them safe. You can add new cabinets whenever you want.
Overall size: 90×47×167 cm

This combination in white Rp**3.470.000** (292.494.01)

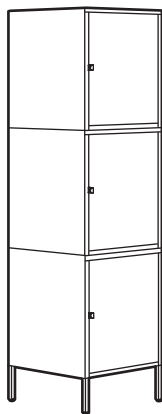

HÄLLAN storage combination with doors. Perfect combination for small spaces with its vertical size. You can add new cabinets whenever you want. they can be locked with standard padlocks.

Overall size: 45×47×167 cm

This combination in white Rp**1.735.000**(292.493.97)

STORAGE – ALL PARTS AND PRICES

GALANT



GALANT shelf unit 80×120 cm, D45 cm. Max load per shelf 30 kg. May be completed with GALANT add on-unit 80×80 cm.

White	203.651.93	Rp2.999.000
White stained oak veneer	003.651.89	Rp3.299.000
Black stained ash veneer	603.651.91	Rp3.299.000



GALANT add-on unit 80×80 cm, D40 cm. Max load per shelf 30 kg. Can only be used together with drawer unit 80×80 cm, shelf unit 80×80 cm, shelf unit 80×120 cm and roll-front cabinets from GALANT series. We recommend you to fix this furniture to the wall with the enclosed safety strap.

White	403.590.68	Rp1.200.000
White stained oak veneer	703.644.26	Rp1.700.000



GALANT add-on unit 160×80 cm, D40 cm. Max load per shelf 30 kg. Can only be used together with the cabinets with sliding doors from GALANT series. We recommend you to fix this furniture to the wall with the enclosed safety strap.

White	003.590.65	Rp2.500.000
White stained oak veneer	603.644.22	Rp3.000.000



GALANT drawer unit 80×80 cm, D45 cm. May be completed with GALANT add on-unit 80×80 cm.

White	703.651.62	Rp5.999.000
White stained oak veneer	503.651.58	Rp6.299.000
Black stained ash veneer	103.651.60	Rp6.299.000



GALANT cabinet with sliding doors 160×120 cm, D45 cm. Max load per shelf 30 kg. May be completed with GALANT add on-unit 160×80 cm.

White	103.651.36	Rp8.499.000
White stained oak veneer	603.651.34	Rp8.799.000
Black stained ash veneer	003.651.32	Rp8.799.000

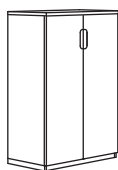

GALANT cabinet with doors 80×120 cm, D45 cm. Max load per shelf 30 kg. Integrated damper makes doors close silently and gently. May be completed with GALANT add-on unit 80×80 cm.

White	903.651.42	Rp3.799.000
White stained oak veneer	703.651.38	Rp3.999.000
Black stained ash veneer	303.651.40	Rp3.999.000



GALANT drawer unit on castors 45×55 cm, D60 cm. Drawers with integrated damper for silent and gentle closing.

White	903.651.56	Rp2.499.000
White stained oak veneer	003.651.51	Rp2.799.000
Black stained ash veneer	403.651.54	Rp2.799.000

HÄLLAN



HÄLLAN cabinet 45×50 cm, D47 cm. You can combine these cabinets as you like and create the exact solution you need at the office or at home. You can buy different sizes so that you can store everything from keys to handbags. Should be completed with HÄLLAN legs.

White	303.637.30	Rp545.000
-------	------------	------------------



HÄLLAN cabinet 45×75 cm, D47 cm. You can combine these cabinets as you like and create the exact solution you need at the office or at home. You can buy different sizes so that you can store everything from keys to handbags. Should be completed with HÄLLAN legs.

White	003.636.23	Rp695.000
-------	------------	------------------

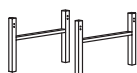

HÄLLAN legs 45×28 cm, D2 cm.

White	903.636.33	Rp100.000
-------	------------	------------------

STORAGE – ALL PARTS AND PRICES

BEKANT



BEKANT storage unit 41×61 cm, D45 cm. Should be completed with BEKANT castors or legs. It can also be used as an extra seat for short time seating.

Mesh/white	603.629.89	Rp1.999.000
Mesh/black	903.630.01	Rp1.999.000



BEKANT storage unit 41×101 cm, D45 cm. Should be completed with BEKANT castors or legs. It can also be used for presentations or short meetings since there is a space for cable behind the shelf and drawer.

Mesh/white	403.629.90	Rp2.999.000
Mesh/black	303.630.04	Rp2.999.000



BEKANT storage unit 61×101 cm, D45 cm. Should be completed with BEKANT castors or legs. It can also be used as reception desk thanks to the generous surface.

Mesh/white	203.629.91	Rp3.499.000
Mesh/black	603.630.07	Rp3.499.000



BEKANT castors 4 pack, Ø8 cm.

White	003.724.58	Rp300.000
Black	603.724.55	Rp300.000



BEKANT shelving unit 121×134 cm, D45 cm.

White	203.735.03	Rp4.799.000
Black	903.734.96	Rp4.799.000

IDÅSEN



IDÅSEN drawer unit on castors 42×61 cm, D47 cm. You can roll it wherever you need thanks to the castors.

Beige	303.207.31	Rp1.799.000
Dark grey	103.609.83	Rp1.799.000
Golden-brown	303.980.89	Rp1.799.000



IDÅSEN cabinet with doors and drawers 80×119 cm, D47 cm. Should be attached to the wall.

Beige	503.207.30	Rp3.999.000
Blue	203.979.43	Rp3.999.000



IDÅSEN high cabinet with doors and drawers 45×172 cm, D47 cm. Should be attached to the wall.

Beige	103.207.32	Rp2.999.000
Blue	103.609.78	Rp2.999.000

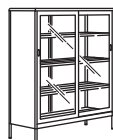

IDÅSEN cabinet with glass doors 120×140cm, D45 cm. Should be attached to the wall.

Beige	603.609.52	Rp4.799.000
-------	------------	--------------------

STORAGE ACCESSORIES



KVISSLE letter tray. Cork liner in the bottom keeps the papers in place. Pull-out compartments make it easy for you to access your papers. You can also turn the letter tray on its side if you want to store and organise your papers vertically.

White 802.039.56 **Rp349.000**

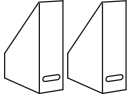

KVISSLE magazine file, set of 2. Easy to pull out and lift as the magazine file has a handle.

White 202.039.59 **Rp199.000**

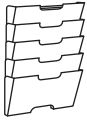

KVISSLE magazine rack. You can hang KVISSLE magazine rack on the wall, on the side of GALANT storage units (cabinet with sliding doors, roll-front and file cabinets, shelf, add-on and drawer units) or use it horizontally in the top drawer of GALANT drawer unit on castors (45×55). Different wall materials require different types of fixing devices. Use fixing devices suitable for the walls in your home, sold separately.

White 401.980.18 **Rp249.000**



SUMMERA drop file, 16-pack. Suitable for A4-size papers.

Patterned 002.522.67 **Rp159.000**

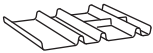

SUMMERA drawer insert with 6 compartments, 44×37 cm, H3 cm. Drawer inserts help organising small things in a big drawer.

Anthracite 002.224.59 **Rp79.000**

WORK CHAIRS



Work chairs that make a perfect match

We have comfortable work chairs for all your needs – swivel chairs for your desk, visitor’s chairs and conference chairs. And in many different styles, colours and materials, so it’s easy to find the perfect match for both you – and your office décor.

Our swivel chairs have features from simple to advanced. How to choose? Start by thinking about what kind activities you will do and how much time you will spend sitting in the chair. For fulltime work, you might need one with more adjustable features to help you vary sitting positions. Do you have special needs, e.g. want relief for your back, support for your arms and shoulders? What style do you like? Let your answers to these questions guide you to the perfect work chair for you.

Can take a tough day at work

Our professional chairs have been tested for office use and meets the requirements for safety, durability and stability set forth in the following standards: EN1335-2 and ANSI/BIFMA x5.1 for desk chairs and EN1022, EN15373 and ANSI/BIFMA x5.1 for conference chairs.

This means we have put the chairs through many different tests and tough challenges. For example, we sized the chair according to both European and American measurement requirements, subjected it to heavy loads and tested the endurance of each part – up to 300,000 times. We did all this to make sure it would be comfortable to sit in, safe to use and capable of enduring fulltime deskwork – for many years.



Read more in the guarantee brochure.

GOOD TO KNOW

The human body is made to move, so ideally, your workspace should give you the choice of sitting, standing or leaning, allowing you to change positions often.

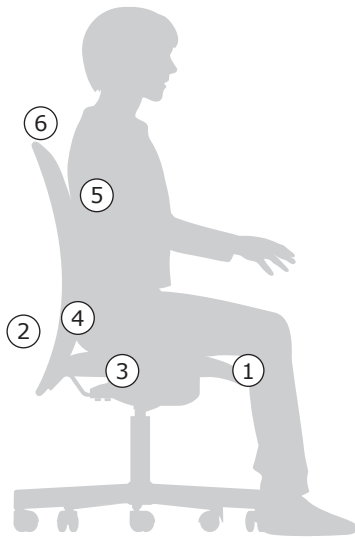

SITTING

1. You should be able to stretch your legs under the table and turn 90° to the left and right. The hips and knees should be at an angle of approx. 95-100° with your feet flat on the floor. If you share the chair with other people, the height adjustable seat allows all of you to sit comfortably.
2. It doesn't matter if you're short or tall. With an adjustable seat depth or a height adjustable backrest you can try different depths and heights and get exactly the support your legs and back need.
3. A chair with tilt function makes it easy to change sitting position, regardless of whether the tilt function is in the seat or the backrest – or in both places.
4. The lumbar region is where we usually feel the first onset of tiredness. A chair with built-in lumbar support relieves pressure on your back.
5. Armrests reduce strain on arms and shoulders. Adjustable armrests reduce strain even more – regardless of how tall or short you are. Make sure that the armrests don't prevent the chair from being drawn close to the desk, and that they don't restrict your movements.
6. If you've been sitting at your desk for some time, it may feel nice to lean back and change your position for a moment. With a headrest on your chair, your head and neck also get some well-deserved relaxation.

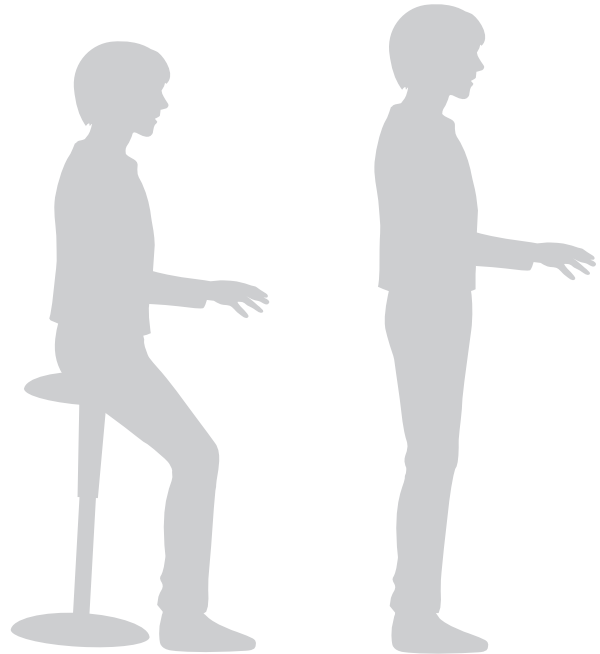

LEANING

A standing support enables a position between sitting and standing, and it's ideal when you have a height adjustable desk.

- Provides freedom of movement for your upper and lower body.
- Activates and strengthens your body's core muscles.
- Gives you an open posture which improves your circulation and metabolic rate.

STANDING

Don't forget to stand up as well. Alternating between sitting and standing is good for you since it increases circulation and productivity. Check out our height adjustable desks since they're ideal for alternating between sitting, leaning and standing.

GOOD TO KNOW



Height adjustable seat for a comfortable sitting posture regardless of body height.



Adjustable seat depth; easy to adapt for increased support to your thighs and back.



Height adjustable backrest; gives lumbar support and relieves strain on your back.



Lockable tilt function for increased stability in different sitting positions.



Adjustable tilt tension; increase or decrease the resistance to suit your movements and weight.



Synchronised tilt function in seat and backrest; the chair follows your movements when you lean forward or back.



Weight compensation mechanism automatically finds the right amount of tilt tension to open up your body when you lean back.

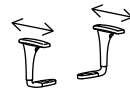

Depth adjustable armrest; adjust the depth according to your needs.

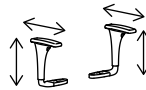

Height and depth adjustable armrests; adjust to relieve strain on your arms and shoulders even more.

SAFETY CASTORS

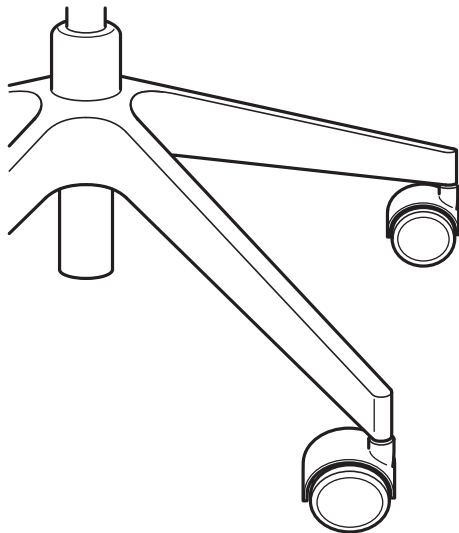

Chairs should stay where you leave them and not roll away on their own. That's why we put safety castors on our chairs. The castors have a built-in pressure-sensitive brake mechanism so that they roll freely and easily when you sit on the chair – and brake when you stand up. Note that even though the castors don't roll when braked, they can still slide on the floor if the chair is pushed.

ALL PARTS AND PRICES

SWIVEL CHAIRS



10
Year
Guarantee

MARKUS swivel chair. Seat W53xD47 cm. Tested for 110 kg. Height adjustable 48–57 cm. This chair is tested and approved for office use. Rubber-coated castors; run smoothly on any type of floor. Design: Henrik Preutz.



ROBUST black	501.372.08	Rp 2.999.000
--------------	------------	---------------------



10
Year
Guarantee

LÅNGFJÄLL swivel chair with high back, 4 legs. Seat W53xD41 cm. Tested for 110 kg. An ergonomic office chair with lightly curved lines, attention to the sewn details and an easy-to-use mechanism hidden under the seat to highlight the design.

GUNNARED beige/black	791.750.54	Rp 2.199.000
GUNNARED beige/white	892.523.44	Rp 2.199.000
GUNNARED blue/black	191.751.13	Rp 2.199.000
GUNNARED blue/white	992.523.48	Rp 2.199.000
GUNNARED light brown-pink/black	492.611.52	Rp 2.199.000
GUNNARED light brown-pink/white	492.523.60	Rp 2.199.000
GUNNARED dark grey/black	691.750.64	Rp 2.199.000
GUNNARED dark grey/white	192.523.52	Rp 2.199.000
GUNNARED light green/black	491.752.39	Rp 2.199.000
GUNNARED light green/white	292.523.56	Rp 2.199.000



FREE
10
Year
Guarantee

ALEFJÄLL swivel chair. Seat W51xD42 cm. Tested for 110 kg. Height adjustable 45–56 cm. An ergonomic office chair with a traditional look.

GLOSE black	503.674.59	Rp 4.999.000
GRANN beige	603.202.25	Rp 4.999.000
GRANN golden-brown	204.199.83	Rp 4.999.000



FREE
10
Year
Guarantee

JÄRVFJÄLLET swivel chair. Seat W52xD46 cm. Tested for 110 kg. Height adjustable 45–56 cm. The mesh material of the backrest lets air through to your back during long sitting periods. You can adjust the lumbar support and seat depth according to your body.

GLOSE black	103.635.52	Rp 3.299.000
GUNNARED dark grey	003.635.95	Rp 2.999.000
GUNNARED blue	603.636.01	Rp 2.999.000



10
Year
Guarantee

LÅNGFJÄLL swivel chair, 5 legs with castors. Seat W53xD41 cm. Tested for 110 kg. An ergonomic office chair with lightly curved lines, attention to the sewn details and an easy-to-use mechanism hidden under the seat to highlight the design.

GUNNARED beige/black	691.775.67	Rp 2.499.000
GUNNARED beige/white	992.523.67	Rp 2.499.000
GUNNARED blue/black	391.775.78	Rp 2.499.000
GUNNARED blue/white	292.523.80	Rp 2.499.000
GUNNARED light brown-pink/black	992.610.79	Rp 2.499.000
GUNNARED light brown-pink/white	292.523.99	Rp 2.499.000
GUNNARED dark grey/black	991.775.75	Rp 2.499.000
GUNNARED dark grey/white	192.523.85	Rp 2.499.000
GUNNARED light green/black	691.775.86	Rp 2.499.000
GUNNARED light green/white	092.523.95	Rp 2.499.000



JÄRVFJÄLLET pair of armrests. Relieves the pressure on arms and shoulders. Fits JÄRVFJÄLLET swivel chairs.

Black	803.636.24	Rp 500.000
-------	------------	-------------------



10
Year
Guarantee

LÅNGFJÄLL swivel chair, 4 legs. Seat W53xD41 cm. Tested for 110 kg. An ergonomic office chair with lightly curved lines, attention to the sewn details and an easy-to-use mechanism hidden under the seat to highlight the design.

GUNNARED beige/black	391.749.66	Rp 1.999.000
GUNNARED beige/white	292.522.95	Rp 1.999.000
GUNNARED blue/black	691.749.79	Rp 1.999.000
GUNNARED blue/white	392.523.08	Rp 1.999.000
GUNNARED light brown-pink/black	392.610.01	Rp 1.999.000
GUNNARED light brown-pink/white	692.523.40	Rp 1.999.000
GUNNARED dark grey/black	491.749.75	Rp 1.999.000
GUNNARED dark grey/white	292.522.76	Rp 1.999.000
GUNNARED light green/black	691.749.84	Rp 1.999.000
GUNNARED light green/white	592.523.12	Rp 1.999.000



10
Year
Guarantee

LÅNGFJÄLL swivel chair with high back, 5 legs with castors. Seat W53xD41 cm. Tested for 110 kg. An ergonomic office chair with lightly curved lines, attention to the sewn details and an easy-to-use mechanism hidden under the seat to highlight the design.

GUNNARED beige/black	691.776.28	Rp 2.699.000
GUNNARED beige/white	892.524.81	Rp 2.699.000
GUNNARED blue/black	591.776.62	Rp 2.699.000
GUNNARED blue/white	092.525.12	Rp 2.699.000
GUNNARED light brown-pink/black	392.611.00	Rp 2.699.000
GUNNARED light brown-pink/white	792.525.42	Rp 2.699.000
GUNNARED dark grey/black	191.776.40	Rp 2.699.000
GUNNARED dark grey/white	192.525.16	Rp 2.699.000
GUNNARED light green/black	691.777.51	Rp 2.699.000
GUNNARED light green/white	392.525.20	Rp 2.699.000



ALL PARTS AND PRICES



LÅNGFJÄLL pair of armrests. Relieves the pressure on arms and shoulders. Fits LÅNGFJÄLL swivel chairs.

Black	303.205.66	Rp 500.000
White	503.205.70	Rp 500.000

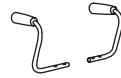

NOMINELL pair of armrests. Relieves the pressure on arms and shoulders. Fits FLINTAN swivel chairs.

Black	702.002.70	Rp 250.000
-------	------------	-------------------



FREE
10
Year
Guarantee

HATTEFJÄLL swivel chair. Seat W50×D40 cm. Tested for 110 kg. Height adjustable 41-52 cm. An ergonomic office chair with gently curved lines.

GUNNARED beige	003.202.28	Rp 3.499.000
----------------	------------	---------------------

GUNNARED medium grey	803.413.35	Rp 3.499.000
----------------------	------------	---------------------

GUNNARED light brown-pink	003.413.44	Rp 3.499.000
---------------------------	------------	---------------------

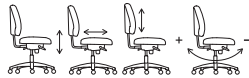

HATTEFJÄLL pair of armrests. Relieves the pressure on arms and shoulders. Fits HATTEFJÄLL swivel chairs.

White	103.413.48	Rp 500.000
-------	------------	-------------------



FLINTAN swivel chair. Seat W47×D48 cm. Tested for 110 kg. Height adjustable 47-60 cm. Self adjusting tilt tension. May be completed with NOMINELL armrests. Rubber-coated castors; run smoothly on any type of floor. Design: Henrik Preutz.

VISSLE black	003.368.42	Rp 999.000
--------------	------------	-------------------

VISSLE grey	003.368.37	Rp 999.000
-------------	------------	-------------------



NILSERIK standing support. Seat diameter 35 cm. Tested for 110 kg. Height adjustable 51-71 cm. Gives you an active sitting position.

Black/VISSLE black	103.499.57	Rp 945.000
--------------------	------------	-------------------

White/VISSLE grey	703.097.22	Rp 945.000
-------------------	------------	-------------------



FREE
10
Year
Guarantee

TROLLBERGET active sit/stand support. Tested for 110 kg. Height adjustable 66-80 cm. Gives you an active sitting position thanks to tilting mechanism of the seat.

GLOSE black	803.882.57	Rp 1.999.000
-------------	------------	---------------------

GRANN beige	803.882.62	Rp 1.999.000
-------------	------------	---------------------



ALL PARTS AND PRICES

CONFERENCE CHAIRS



FREE
10
Year
Guarantee

FJÄLLBERGET conference chair. Seat W42×D40 cm. Tested for 110 kg. Height adjustable 43–56 cm. The curved bent wood back and armrests are both comfortable and stylish.

White stained oak veneer/
GUNNARED light beige 604.062.76 **Rp2.999.000**



FREE
10
Year
Guarantee

FJÄLLBERGET conference chair, 5 legs with castors. Seat W42×D40 cm. Tested for 110 kg. Height adjustable 43–56 cm. The curved bent wood back and armrests are both comfortable and stylish.

Black stained oak veneer/
GUNNARED dark grey 603.964.18 **Rp3.299.000**

CHAIR ACCESSORIES



KOLON floor protector. 120×100 cm. Suitable for most types of floors and flat-woven rugs. Not suitable for cork floors or heated wooden floors. If the floor protector is left lying on the floor for a long period a vacuum may form and cause damage to your floor. Therefore, lift the floor protector at regular intervals for ventilation.

901.762.45 **Rp399.000**

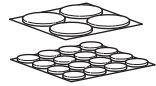

FIXA stick-on floor protectors set of 20. Protects the underlying surface against wear and scratching.

301.887.22 **Rp19.900**

SERVICES

We offer a range of services to help you with everything from putting it together to getting it home. Of course, the more you do yourself, the lower the price will be. And the more we do for you, the more you can sit back and relax!

Delivery service

Add our delivery service to your total cost regardless of whether you're shopping online or in your local store. We can deliver the same day/next day within the store delivery area. And, we don't just stop at your front door, we deliver all the way to your room of choice.

Assembly service

We assemble your IKEA furniture in your home following the assembly instructions. The assembly service includes a free 1-year guarantee on workmanship, and disposal of all packaging in an environmentally friendly way.

It's ok to change your mind

You have 30 days to return your purchase. Keep your receipt safe to make returns easier. You're free to change your mind. Return unused items in their original packaging within 30 days together with proof of purchase for a full refund.