

BUYING GUIDE

KIVIK

Seating series

MODELS

Footstool with storage
Chaise longue
Two-seat sofa
Three-seat sofa



Removable cover



Storage in
footstool



Choice of cover



Leather and
coated fabric



Washable cover



Read more in the
guarantee brochure

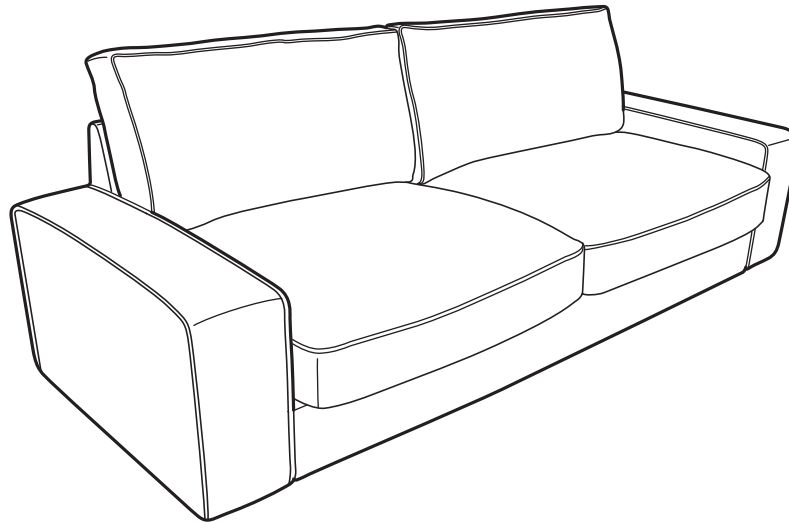

Comfortable sofa at an attractive price

KIVIK seating series is made for people who want extra comfortable seating, without it costing more than necessary. Every detail, inside and out, is adapted to give you as much comfort as possible. You can also combine the different parts in the series in different ways to suit you and your home. This way, you always have room for relaxation.

Follows your body and gives support

The seat cushions in KIVIK seating series have a layer of memory foam that softly follows the contours of your body and gives comfortable support exactly where you need it. The wide armrests have a thick padding that's nice both to rest your neck against and to sit on. If you choose to add a chaise longue and footstool you will have a combination you can really stretch out on. Then you can count on maximum comfort.

Choose your own combination

It's easy to adapt KIVIK seating series to suit your home and your needs. You can, for example, combine the sofas with a generous chaise longue for extra room and comfort. If you want a smaller combination instead, you can use a one-seat section without armrests – and either combine it with several one-seat sections or a chaise longue. You have every possibility to create your own personal solution!

All the products (shown here) may not be available at the store. Please contact the staff or look at www.IKEA.co.id for more information. For more detailed product information, see the price tag and the Internet. All units require assembly.
IKEA Indonesia reserves the right to adjust our prices, to correct price errors or misprints according to any changes beyond our responsible control. IKEA Indonesia tries to ensure that all information stated is correct at the time of publishing.



COMBINATIONS

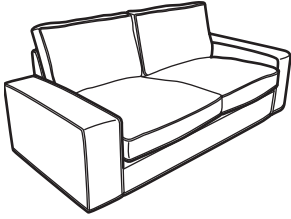

KIVIK 2-seat sofa

Overall size: W190×D95×H83 cm

Total price incl. cover

Orrsta light grey	290.114.18	Rp 4.495.000
Orrsta red	092.529.65	Rp 4.495.000
Borred grey-green	391.840.22	Rp 4.995.000
HILLARED anthracite	291.936.68	Rp 5.995.000
HILLARED beige	591.943.98	Rp 5.995.000
HILLARED dark blue	291.937.34	Rp 5.995.000
Grann/Bomstad black	401.985.89	Rp 15.995.000
Grann/Bomstad dark brown	902.048.42	Rp 15.995.000

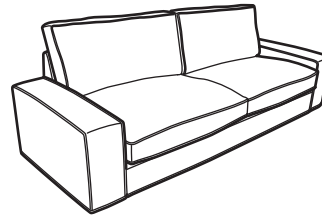

KIVIK 3-seat sofa

Overall size: W228×D95×H83 cm

Total price incl. cover

Orrsta light grey	790.114.30	Rp 5.495.000
Orrsta red	992.529.75	Rp 5.495.000
Borred grey-green	291.840.32	Rp 5.995.000
HILLARED anthracite	191.936.78	Rp 6.995.000
HILLARED beige	291.944.08	Rp 6.995.000
HILLARED dark blue	791.937.55	Rp 6.995.000
Grann/Bomstad black	801.985.92	Rp 17.995.000
Grann/Bomstad dark brown	602.048.53	Rp 17.995.000

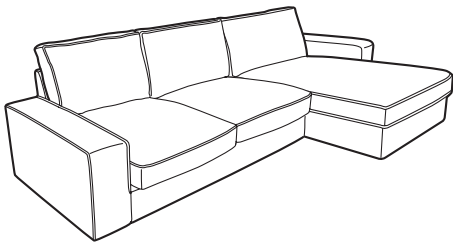

KIVIK 2-seat sofa with chaise lounge

Overall size: W280×D163×H83 cm

Total price incl. cover

Orrsta light grey	590.114.12	Rp 8.990.000
Orrsta RED	192.529.60	Rp 8.990.000
Borred grey-green	391.840.17	Rp 9.990.000
HILLARED anthracite	391.936.63	Rp 11.990.000
HILLARED beige	891.943.92	Rp 11.990.000
HILLARED dark blue	291.937.29	Rp 11.990.000
Grann/Bomstad black	998.943.74	Rp 27.990.000
Grann/Bomstad dark brown	799.046.99	Rp 27.990.000

GOOD TO KNOW

Our fabrics have been tested

At IKEA we test the fabric covers on our sofas and arm-chairs so you can be sure they're durable. The fabric's ability to resist abrasion is tested by using a machine to rub it against another fabric while applying firm pressure. A fabric that can take 15,000 cycles is suitable for furniture that must withstand everyday life at home – and if it can take more than 30,000 cycles, it is very resistant to abrasion. All fabrics are sensitive to sunlight, which is why we also check that our fabrics resist fading effectively.

Durable in different ways

Tough tests are an important way to check the durability of our fabric covers, but they don't tell the whole story. Durability also depends on materials, construction and manner of use. Heavy, tightly woven fabrics with a flat surface are most resistant to abrasion. Fabrics with a mixture of natural and synthetic fibres can withstand abrasion better than fabrics with only natural fibers. Yarn-dyed fabrics are more durable than fabrics with printed patterns. And a dirty cover wears out faster than a clean one. The fabric is also affected by how you use your sofa of course.

	Washing instructions	Resistance to abrasion (cycles)	Light fastness (0-6)
HILLARED: multi-fiber blended, tonal yarn dyed structure.	Machine washable at 40°C.	30,000	5
BORRED: soft microfiber structure with subtle mélange effect.	Machine washable at 40°C.	20,000	5
ORRSTA: two toned subtle structure	Machine washable at 40°C.	20,000	5

LEATHER SOFAS

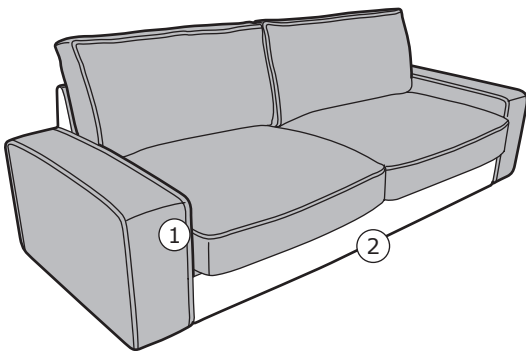

KIVIK in leather and coated fabric

The KIVIK leather sofa is a mix of 1,6 mm GRANN grain leather, which is a soft and high quality leather and BOMSTAD coated fabric, with the look and feel of leather at a lower cost. This is why IKEA often uses a combination of both, with leather on direct contact surfaces such as seating surfaces and armrests (1), and coated fabric on other surfaces (2).

Grain Leather

The natural variations in the hide are visible, because it's treated with only a light surface coating for protection. The leather will acquire a beautiful patina over time and is easy to look after. Just vacuum regularly and treat with ABSORB leather care set to keep the leather soft, supple and fresh looking.





Coated fabric

Coated fabric is a fabric material with a coating, which can be embossed to look like leather. It's a strong and durable material and very easy to care for – just vacuum the surface using the soft brush attachment on your vacuum cleaner and wipe with a damp cloth.

Durability

All our different leather and coated fabrics have been treated to protect them and make them easy for you to look after. All have also been tested and approved for tear strength, flexibility and colour fastness, so you can be sure you will enjoy your new sofa or armchair for many years to come.

ALL PARTS AND PRICES

	 Footstool with storage	 Chaise longue	 2-seat sofa	 3-seat sofa
Width×Depth×Height in cm	90×70×43	90×163×83	190×95×83	228×95×83
Complete with cover				
ORRSTA light grey	Rp 2.295.000	Rp 4.495.000	Rp 4.495.000	Rp 5.495.000
ORRSTA Red	Rp 2.295.000	Rp 4.495.000	Rp 4.495.000	Rp 5.495.000
BORRED grey-green	Rp 2.795.000	Rp 4.995.000	Rp 4.995.000	Rp 5.995.000
HILLARED anthracite	Rp 2.995.000	Rp 5.995.000	Rp 5.995.000	Rp 6.995.000
HILLARED beige	Rp 2.995.000	Rp 5.995.000	Rp 5.995.000	Rp 6.995.000
HILLARED dark blue	Rp 2.995.000	Rp 5.995.000	Rp 5.995.000	Rp 6.995.000
Extra cover				
ORRSTA light grey	Rp 500.000	Rp 1.000.000	Rp 1.200.000	Rp 1.500.000
ORRSTA Red	Rp 500.000	Rp 1.000.000	Rp 1.200.000	Rp 1.500.000
BORRED grey-green	Rp 1.000.000	Rp 1.500.000	Rp 1.700.000	Rp 2.000.000
HILLARED anthracite	Rp 1.200.000	Rp 2.500.000	Rp 2.700.000	Rp 3.000.000
HILLARED beige	Rp 1.200.000	Rp 2.500.000	Rp 2.700.000	Rp 3.000.000
HILLARED dark blue	Rp 1.200.000	Rp 2.500.000	Rp 2.700.000	Rp 3.000.000
Complete with fixed leather cover				
GRANN black	Rp 4.995.000	Rp 11.995.000	Rp 15.995.000	Rp 17.995.000
GRANN dark brown	Rp 4.995.000	Rp 11.995.000	Rp 15.995.000	Rp 17.995.000